

MM 56

***STIHL***



2 - 21      Instruction Manual



# Contents

1	MultiSystem.....	2
2	Guide to Using this Manual.....	2
3	Safety Precautions and Working Techniques.....	2
4	Approved MultiTools.....	7
5	Adjusting the bicycle handle.....	8
6	Fuel.....	8
7	Fueling.....	9
8	Starting / Stopping the Engine.....	9
9	Extra weight.....	12
10	Wheels.....	12
11	Operating Instructions.....	13
12	Replacing the Air Filter.....	14
13	Adjusting the Carburetor.....	14
14	Spark Arresting Screen in Muffler.....	14
15	Spark Plug.....	14
16	Engine Running Behavior.....	15
17	Storing the Machine.....	15
18	Maintenance and Care.....	16
19	Minimize Wear and Avoid Damage.....	17
20	Main Parts.....	18
21	Specifications.....	19
22	Maintenance and Repairs.....	20
23	Disposal.....	20
24	EC Declaration of Conformity.....	21

## 1 MultiSystem

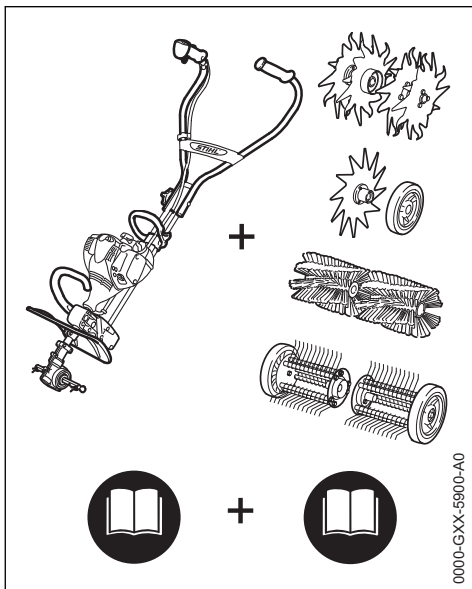

In the STIHL MultiSystem a number of different MultiEngines and MultiTools can be combined to produce a power tool. In this instruction manual

the functional unit formed by the MultiEngine and MultiTool is referred to as the power tool.

Therefore, the separate instruction manuals for the MultiEngine and MultiTool should be used together for the power tool.

Always read and make sure you understand **both** instruction manuals before using your power tool for the first time and keep them in a safe place for future reference.

## 2 Guide to Using this Manual

### 2.1 Pictograms

All the pictograms attached to the machine are shown and explained in this manual.

### 2.2 Symbols in text

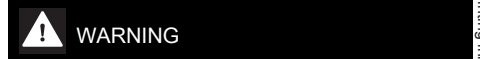

Warning where there is a risk of an accident or personal injury or serious damage to property.



Caution where there is a risk of damaging the machine or its individual components.

### 2.3 Engineering improvements

STIHL's philosophy is to continually improve all of its products. For this reason we may modify the design, engineering and appearance of our products periodically.

Therefore, some changes, modifications and improvements may not be covered in this manual.

## 3 Safety Precautions and Working Techniques

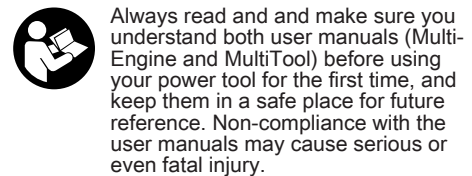
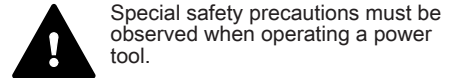

Observe all applicable local safety regulations, e.g., by employers' liability insurance associa-

tions, social insurance systems, occupational safety authorities, etc.

If you have never used a power tool before: Have your dealer or other experienced user show you how to operate your machine – or attend a special course to learn how to operate it.

Minors should never be allowed to use the motorized device – except for apprentices over the age of 16 when working under supervision.

Children, animals and onlookers must remain at a safe distance.

When not using the machine, it must be laid down in such a way that it does not endanger anyone. Ensure that the machine cannot be used without authorization.

The user is responsible for accidents or risks involving third parties or their property.

Lend or rent your power tool only to persons who are familiar with this model and its operation – do not lend or rent your power tool without the MultiEngine and MultiTool user manuals.

The use of noise emitting power tools may be restricted to certain times by national or local regulations.

Anyone operating the machine must be well rested, in good physical health and in a good state of mind.

If you have any condition that might be aggravated by strenuous work, check with your doctor before operating a machine.

Persons with pacemakers only: The ignition system of your power tool produces an electromagnetic field of a very low intensity. This field may interfere with some pacemakers. STIHL recommends that persons with pacemakers consult their physician and the pacemaker manufacturer to minimize any health risk.

Anyone who has consumed alcohol, medications or drugs that impair their ability to react must not operate a power tool.

Use your power tool only for the applications described in the user manual of the MultiTool you are using.

The machine must not be used for any other purposes – **risk of accident!**

Do not operate the MultiEngine without a properly mounted MultiTool since this may result in damage to the machine.

Only use MultiTools and accessories that are explicitly approved for this power tool by STIHL or are technically identical. It is important that you read the chapter on "Approved MultiTools". If you have any questions in this respect, consult your dealer. Use only high-quality parts and accessories. In order to avoid the risk of accidents and damage to the machine.

STIHL recommends the use of genuine STIHL tools and accessories. They are specifically designed to match the product and meet your performance requirements.

Never attempt to modify your power tool in any way since this may increase the risk of personal injury. STIHL excludes all liability for personal injury and damage to property caused while using unauthorized attachments.

Do not use a high-pressure washer to clean the power tool. The solid jet of water may damage parts of the unit.

### 3.1 Clothing and Equipment

Wear proper protective clothing and equipment.

Do not wear clothing which could become trapped in wood, brush or moving parts of the machine. Do not wear a scarf, necktie or jewelry. Tie up and secure long hair above your shoulders.



Wear steel-toed safety boots with non-slip soles.



#### WARNING



To reduce the risk of eye injuries, wear close-fitting safety glasses in accordance with European Standard EN 166. Make sure the safety glasses are a snug fit.

Wear "personal" sound protection, e.g. ear defenders.

Wear face protection and make sure it is a good fit. Face protection alone is not sufficient to protect the eyes.

See also notes on "Clothing and Equipment" in the user manual of the MultiTool you are using.

## 3.2 Transporting the machine

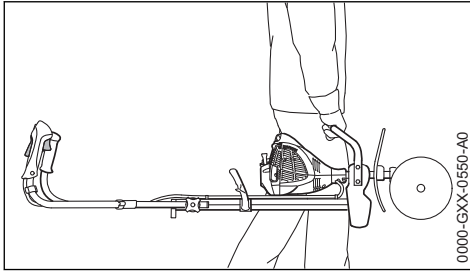

Always stop the engine.

Transport the machine by the handle or loop handle, working tool facing forward.

Never touch hot parts – **risk of burns!**

The power tool can turn over or move while being transported. Persons may be injured or property may be damaged. Secure the power tool with lashing straps or a net to prevent it turning over and moving. Allow the power tool to cool down before transporting it by vehicle. Position the power tool so that no fuel can escape.

See also notes on "Transporting the Power Tool" in the user manual of the MultiTool you are using.

## 3.3 Refueling



**Gasoline is highly flammable** – keep away from fire or flame – do not spill any fuel – no smoking.

Always shut off the engine before refueling.

Do not fuel a hot engine – **fuel may spill and cause a fire.**

Open the fuel cap carefully to allow any pressure build-up in the tank to release slowly and to prevent fuel spraying out.

Only refuel the machine in a well ventilated place. If fuel has been spilled, immediately clean the machine – do not allow your clothes to be splashed with fuel. If that happens, change your clothes at once.



After fueling, tighten down the screw-type fuel cap as securely as possible.

This helps reduce the risk of engine vibrations causing an incorrectly tightened fuel cap to loosen or come off and spill fuel.



Check for fuel leakage! Never start the engine if fuel has been spilled or is leaking – **fatal burns may result!**

## 3.4 Before starting

Check that your power tool is properly assembled and in good condition – refer to appropriate chapters in the User Manuals:

- Check the fuel system for leaks, especially the visible parts, e. g., fuel cap, hose connections, manual fuel pump (only in machines with a manual fuel pump). In case of leakage and damage, do not start the engine – **risk of fire!** Have the machine serviced by a dealer before using it
- Use only an approved combination of attachment and deflector. All parts must be assembled properly and securely.
- The stop switch must be easy to push
- Smooth action of throttle trigger lockout and throttle trigger – the throttle trigger must return automatically to the idle position
- Check that the spark plug boot is secure – a loose boot may cause arcing that could ignite combustible fumes **and cause a fire.**
- Do not make any changes to the controls or the safety devices.
- Keep the handles dry and clean – free from oil and dirt – for safe control of the power tool.
- Swing the bike handle to the normal operating position and tighten it down firmly with the rotary knob. See "Adjusting the Bike Handle".

The power tool must only be operated when it is in good operating condition – **Risk of accident!**

See also notes on "Before Starting" in the user manual of the MultiTool you are using.

Check the position of the gearbox for the MultiTool you have mounted and correct it if necessary. This helps reduce the risk of injury **from the MultiTool** rotating in the wrong direction.

See "Installing the MultiTool" in the User Manual of the MultiTool you are using.

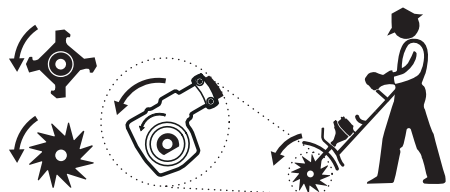

Arrows on the rotor blades show the direction of rotation. The arrows on the rotor blades must point in the same direction as the arrows on the gear.



Ensure that the gear unit and the rotor blades are correctly attached and aligned and avoid contact with the rotor blades - **risk of injury!**

If you use metal tools, position the gearbox so that the axle is below the drive shaft.

Use this position for:

- BF-MM cultivator
- BK-MM bolo tines
- FC-MM edger
- RL-MM aerator
- MF-MM dethatcher

If you use sweeping attachments, position the gearbox so that the axle is above the drive shaft.

Use this position for:

- KB-MM bristle brush
- KW-MM sweeper drum assembly

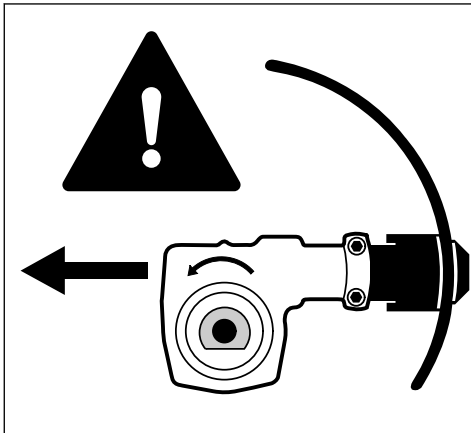

To use MultiTools for mowing grass, trimming and thinning out, remove the gearbox.

Use this position for:

- Clearing saw FS-MM

### 3.5 Starting the engine

Start the engine at least 3 meters from the refueling spot and only outdoors.

Place the power tool on firm ground in an open area. Make sure you have good balance and secure footing. Hold the power tool securely. The attachment must be clear of the ground and all

other obstructions because it may begin to run when the engine starts.

Your power tool is for operation by one person only. To reduce the risk of injury from contact with the rotating tool, do not allow other persons within a radius of 5 meters of your own position – even when starting.



The tool begins to rotate as soon as the engine is started in the "Start" position. Always stand to one side of the machine when starting – never in front of the tool. **To reduce the risk of injury**, avoid contact with the working tool.

Do not drop-start the power tool – start the engine as described in the User Manual. Note that the attachment continues to run for a short period after you let go of the throttle trigger – fly-wheel effect.

Check idle speed setting: The attachment must be stationary when the engine is idling with the throttle trigger released.

Keep easily combustible materials (e.g., wood chips, bark, dry grass, fuel) away from hot exhaust gases and hot muffler surfaces – **risk of fire!**

See also notes on "Starting / Stopping the Engine" in the user manual of the MultiTool you are using.

### 3.6 Holding and Controlling the Power Tool

Make sure you always have a firm and secure footing.

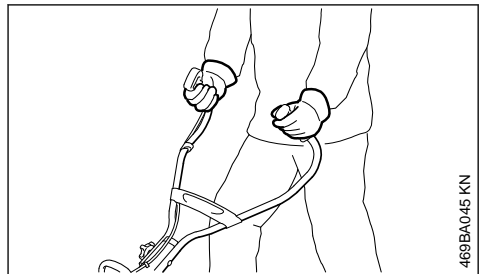

Always hold the unit firmly with both hands on the handles.

Right hand on control handle, left hand on grip on handlebar.

### 3.7 While Working

In the event of impending danger or in an emergency, switch off the engine immediately by pressing the stop switch.



To reduce the **risk of injury** from contact with the tool and ejected objects, do not allow any other persons within a radius of 5 meters of your own position. This distance must also be maintained in relation to objects (vehicles, window panes) – **risk of property damage!**

The correct engine idle speed is important to ensure that the work tool stops moving when you let go of the throttle trigger. If the working tool continues to move when the engine is idling, have your dealer check the machine and make proper adjustments or repairs. Check and correct the idle speed setting at regular intervals. STIHL recommends you have this work done by a STIHL servicing dealer.

Do not operate your power tool in the starting throttle position – engine speed cannot be controlled in this position.

Be particularly alert and cautious when wearing ear protection because your ability to hear warnings (shouts, alarms, etc.) is impaired.

Take breaks when you start getting tired or feeling fatigue – **risk of accidents!**

Work calmly and carefully – in daylight conditions and only when visibility is good. Proceed with caution, do not put others in danger.

Use your power tool only for those applications described in the MultiTool user manual.



As soon as the engine starts running, the power tool generates toxic exhaust gas. These gases may be odorless and invisible and may contain unburned hydrocarbons and benzene. Never run the engine indoors or in poorly ventilated locations, even if your model is equipped with a catalytic converter.

To reduce the risk of **serious or fatal injury from breathing toxic fumes**, ensure proper ventilation when working in trenches, hollows or other confined locations.

Stop work immediately if you start suffering from nausea, headaches, impaired vision (e.g. your field of vision gets smaller), impaired hearing, dizziness, or impaired concentration – these symptoms may possibly be the result of too-high exhaust gas concentration – **Risk of accidents!**

Operate your power tool in such a way that it produces a minimum of noise and emissions – do not run the engine unnecessarily, accelerate the engine only when working.

To reduce the risk of fire, **do not smoke** while operating or standing near your power tool. Combustible fuel vapor may escape from the fuel system.

Dust, fumes and smoke produced while working may be hazardous to health. Wear respiratory protection in case of heavy dust or smoke emission.

Never touch hot parts – **risk of burns!**



Keep your hands and feet well away from the working tool. **To reduce the risk of injury**, never touch a rotating tool. Always stand behind the deflector or to one side of the machine during operation – never in front of the rotating tools.

If your power tool is subjected to unusually high loads for which it was not designed (e.g. heavy impact or a fall), always check that it is in good condition before continuing work – see also "Before Starting". Check in particular that the fuel system has no leaks and the safety equipment is fully operative. Never use a power tool that is no longer safe to operate. In case of doubt, contact a dealer.

**To reduce the risk of injury**, shut off the engine before changing the attachment.

After finishing work or before leaving the power tool unattended: Shut off the engine.

See also notes on "During Operation" in the User Manual of the MultiTool you are using.

### 3.8 Vibrations

Prolonged use of the power tool may result in vibration-induced circulation problems in the hands (whitefinger disease).

No general recommendation can be given for the length of usage because it depends on several factors.

The period of usage is prolonged by:  
– Hand protection (wearing warm gloves)

- Work breaks

The period of usage is shortened by:

- Any personal tendency to suffer from poor circulation (symptoms: frequently cold fingers, tingling sensations).
- Low outside temperatures.
- The force with which the handles are held (a tight grip restricts circulation).

Continual and regular users should monitor closely the condition of their hands and fingers. If any of the above symptoms appear (e.g. tingling sensation in fingers), seek medical advice.

### 3.9 Maintenance and Repairs

Service the machine regularly. Do not attempt any maintenance or repair work not described in the instruction manual. Have all other work performed by a servicing dealer.

STIHL recommends that you have servicing and repair work carried out exclusively by an authorized STIHL servicing dealer. STIHL dealers are regularly given the opportunity to attend training courses and are supplied with the necessary technical information.

Only use high-quality replacement parts in order to avoid the risk of accidents and damage to the machine. If you have any questions in this respect, consult a servicing dealer.

STIHL recommends the use of genuine STIHL replacement parts. These parts are specifically designed to match your machine model and meet your performance requirements.

To reduce **the risk of injury** from unintentional engine startup, **always shut off the engine and disconnect the spark plug boot** before performing any repairs, maintenance or cleaning work. – Exception: Carburetor and idle speed adjustments.

Do not turn the engine over on the starter with the spark plug boot or spark plug removed since there is otherwise a **risk of fire** from uncontained sparking.

To reduce the **risk of fire**, do not service or store your machine near open flames.

Check the fuel filler cap for leaks at regular intervals.

Use only a spark plug of the type approved by STIHL and make sure it is in good condition – see "Specifications".

Inspect the ignition lead (insulation in good condition, secure connection).

Check the condition of the muffler.

To reduce the **risk of fire and damage to hearing**, do not operate your machine if the muffler is damaged or missing.

Do not touch a hot muffler since **burn injury** will result.

## 4 Approved MultiTools

The following STIHL MultiTools may be mounted on the MultiEngine:

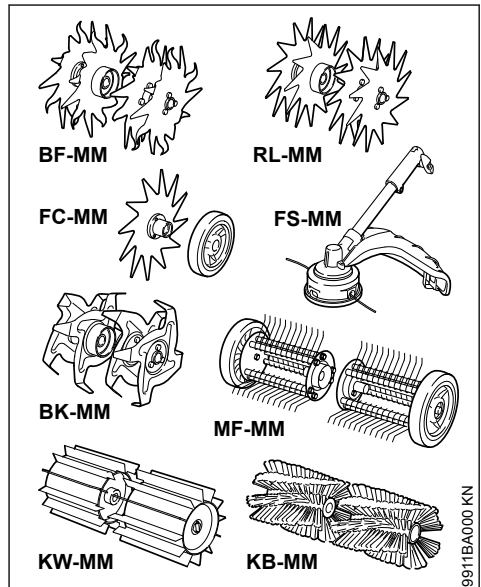

MultiTool	Application
BF-MM	Pick tines
BK-MM	Bolo tines
RL-MM	Aerator
FC-MM	Edger
FS-MM	Clearing saw
MF-MM	Dethatcher
KW-MM	STIHL PowerSweep™
KB-MM	Bristle brush

## 5 Adjusting the bicycle handle

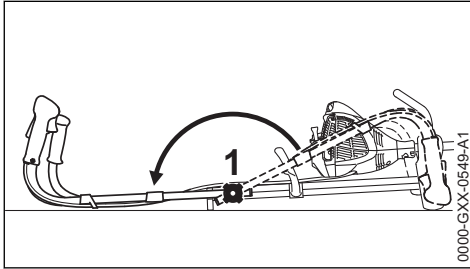

- ▶ Loosen the knob (1).
- ▶ Swing the bicycle handle with both hands into the working position (as far as stop).
- ▶ Tighten down the knob firmly.

## 6 Fuel

The engine requires a mixture of gasoline and engine oil.



### WARNING

Avoid direct skin contact with fuel and breathing in of gasoline fumes.

### 6.1 STIHL MotoMix

STIHL recommends using STIHL MotoMix. This pre-blended fuel is free of benzene and lead, is distinguished by a high octane rating, and always provides the proper mixing ratio.

STIHL MotoMix uses STIHL HP Ultra two-stroke engine oil for optimum engine life.

MotoMix is not available in all markets.

### 6.2 Mixing fuel

#### NOTICE

Unsuitable fuels or a mixing ratio that deviates from the specification can lead to severe engine damage. The engine, seals, fuel lines and fuel tank may be damaged if low-quality gasoline or engine oil is used.

#### 6.2.1 Gasoline

Use only **high-quality gasoline** with an octane rating of at least 90 ROC – leaded or unleaded.

Gasoline with an alcohol component exceeding 10% can cause impaired engine performance in

engines with manually adjustable carburetors and thus should not be used in these engines.

Engines with M-Tronic deliver full engine performance using gasoline with an alcohol component of up to 27% (E27).

#### 6.2.2 Engine oil

If you mix the fuel yourself, use only STIHL two-stroke engine oil or another high-performance engine oil classified as JASO FB, JASO FC, JASO FD, ISO-L-EGB, ISO-L-EGC or ISO-L-EGD.

STIHL specifies STIHL HP Ultra two-stroke engine oil or an equivalent high-performance engine oil in order to maintain emission limits over the machine's service life.

#### 6.2.3 Mixing ratio

with STIHL two-stroke engine oil 1:50; 1:50 = 1 part oil + 50 parts gasoline

#### 6.2.4 Examples

Quantity of gaso- line	STIHL two-stroke engine oil 1:50
Liters	Liters (ml)
1	0.02 (20)
5	0.10 (100)
10	0.20 (200)
15	0.30 (300)
20	0.40 (400)
25	0.50 (500)

- ▶ Pour oil into an approved safety fuel canister first, then add gasoline and mix thoroughly

### 6.3 Storing fuel mixture

Store in approved safety fuel canisters only in a dry, cool and secure place protected against light and sunlight.

**Fuel mixture deteriorates with age** – mix only as much as needed for a few weeks. Do not store fuel mixture for longer than 30 days. The fuel mixture can become unusable more quickly if exposed to light, sunlight or low or high temperatures.

STIHL MotoMix however can be stored for up to 5 years without any problems.

- ▶ Shake the canister containing the fuel mixture thoroughly before refueling



## WARNING

Pressure may have built up in the canister – open it carefully.

- ▶ The fuel tank and the canister in which fuel mixture is stored should be cleaned thoroughly from time to time

Residual fuel and the liquid used for cleaning must be disposed of in accordance with regulations and without harming the environment!

## 7 Fueling

### 7.1 Preparations

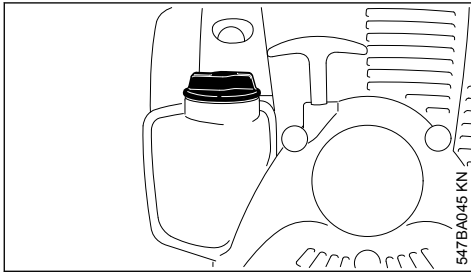

- ▶ Before fueling, clean the filler cap and the area around it to ensure that no dirt falls into the tank.
- ▶ Position the machine so that the filler cap is facing up.

### 7.2 Opening screw-type tank cap

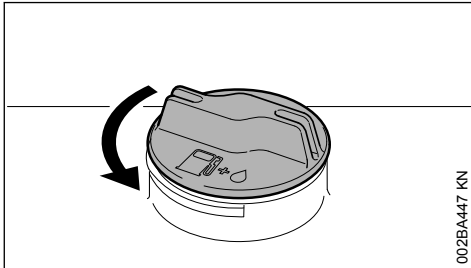

- ▶ Turn the cap counterclockwise until it can be removed from the tank opening.
- ▶ Remove the cap.

### 7.3 Filling up with fuel

Take care not to spill fuel while fueling and do not overfill the tank. STIHL recommends you use the STIHL filler nozzle (special accessory).

### 7.4 Closing screw-type tank cap

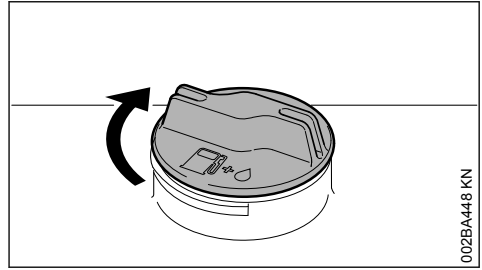

- ▶ Place the cap in the opening.
- ▶ Turn the cap clockwise as far as stop and tighten it down as firmly as possible by hand.

## 8 Starting / Stopping the Engine

### 8.1 Controls

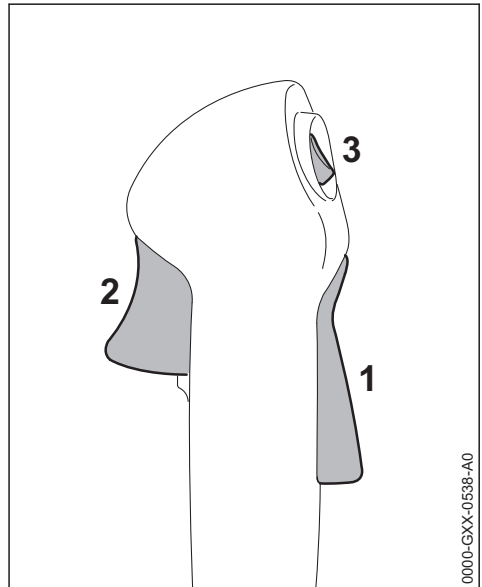

- 1 Throttle trigger lockout
- 2 Throttle trigger
- 3 Stop switch with Run and Stop positions. Depress the stop switch (⊖) to switch off the ignition – see "Function of Stop Switch and Ignition System".

### 8.1.1 Function of Stop Switch and Ignition System

The ignition is switched off and the engine stopped when the stop switch is depressed. The stop switch returns automatically to the **Run** position when it is released: The ignition is switched on again after the engine stops – the engine is then ready to start.

## 8.2 Starting the Engine

- ▶ Swing bicycle handle into working position – see "Adjusting the Bicycle Handle"

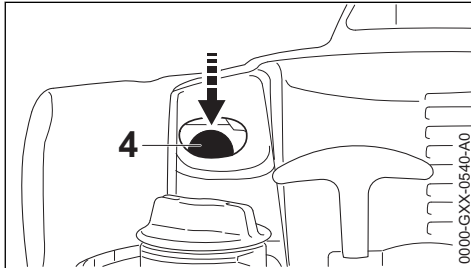

- ▶ Depress the manual fuel pump bulb (4) at least five times – even if the bulb is filled with fuel.

### 8.2.1 Cold engine (cold start)

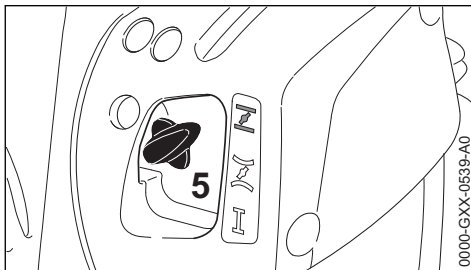

- ▶ Depress the choke knob (5) and turn it to **F** at the same time.

### 8.2.2 Warm engine (warm start)

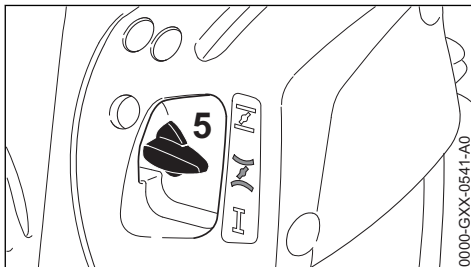

- ▶ Depress the choke knob (5) and turn it to **I** at the same time.

Also use this setting if the engine has been running but is still cold.

### 8.2.3 Cranking

- ▶ Retract the wheels, if fitted.

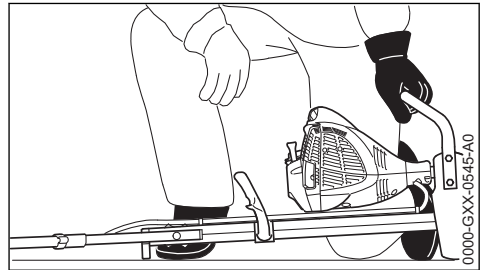

- ▶ Put the unit on the ground: It must rest securely on the engine flange and the support on the frame. Check that the MultiTool is not touching the ground or any other obstacles – see also "Starting / Stopping the Engine" in the MultiTool instruction manual.
- ▶ Make sure you have secure footing – as shown. To reduce **the risk of injury** from the rotating attachment, always stand to one side of the power tool.
- ▶ With your left hand on the carrying handle, press the unit **firmly** against the ground.

**NOTICE**

Do not stand or kneel on the shaft.

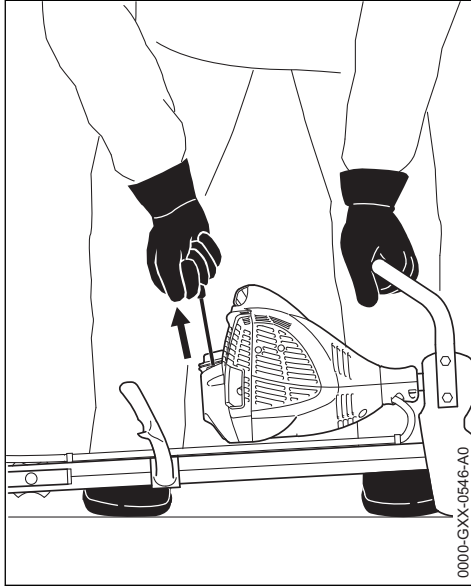

- ▶ Hold the starter grip with your right hand.

**8.2.4 Version without ErgoStart**

- ▶ Pull the starter grip slowly until you feel it engage and then give it a brisk strong pull.

**8.2.5 Version with ErgoStart**

- ▶ Pull the starter grip steadily.

**NOTICE**

Do not pull out the starter rope all the way – it might otherwise break.

- ▶ Do not let the starter grip snap back. Guide it slowly back into the housing so that the starter rope can rewind properly.
- ▶ Continue cranking until the engine runs.

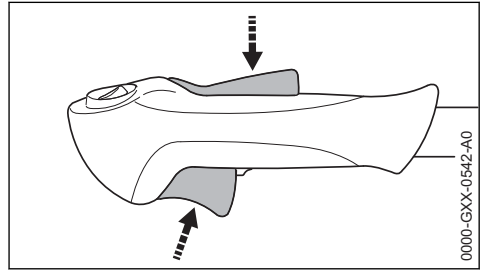
**8.2.6 As soon as the engine runs**

- ▶ Press down the throttle trigger lockout and open the throttle – the choke knob moves to the run position **I**. After a cold start, warm up the engine by opening the throttle several times.

**! WARNING**

Make sure the carburetor is correctly adjusted. The MultiTool must not rotate when the engine is idling.

Your machine is now ready for operation.

**8.3 Stopping the Engine**

- ▶ Depress the momentary contact stop switch – the engine stops – release the stop switch – it springs back to the run position.

**8.4 Other Hints on Starting**

**Engine stalls in cold start position **I** or under acceleration.**

- ▶ Move the choke knob to **II** and continue cranking until the engine runs.

**Engine does not start in warm start position **II****

- ▶ Move the choke knob to **I** and continue cranking until the engine runs.

**If the engine does not start**

- ▶ Check that all settings are correct.
- ▶ Check that there is fuel in the tank and refuel if necessary.
- ▶ Check that the spark plug boot is properly connected.
- ▶ Repeat the starting procedure.

**Engine is flooded**

- ▶ Move the choke knob to **I** and continue cranking until the engine runs.

**Fuel tank run until completely dry**

- ▶ After refueling, depress the manual fuel pump bulb at least 5 times – even if the bulb is already filled with fuel.

- ▶ Set the choke knob to suit the engine temperature.
- ▶ Now start the engine.

## 9 Extra weight

An extra weight (special accessory) may be retrofitted on the MultiEngine to increase the weight on the MultiTool.

Use only original STIHL weights. The use of other weights parts may result in damage to the machine or personal injury.

### 9.1 Mounting the extra weight

#### MultiEngine without wheels

Use the combination wrench to unscrew and retighten the weights.

Unscrew weights on the side without square end – as follows:

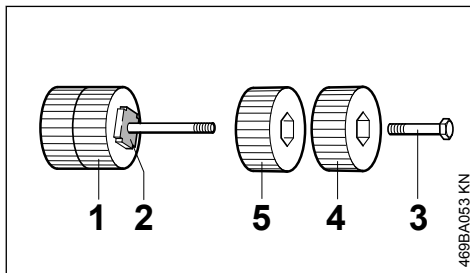

The weights (1) on the side with the square end (2) remain on the bolt.

- ▶ Take out the hex head screw (3) and remove the outer weight (4).
- ▶ Loosen the inner weight (5) and remove it from the bolt.

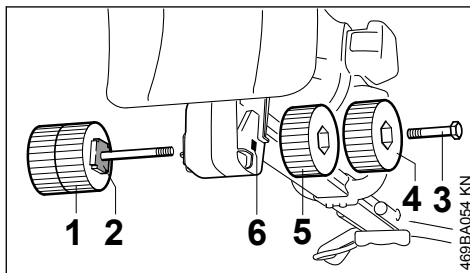

- ▶ Push the extra weight (1) with bolt through the bore (6) in the flange, turning it until the square end (2) engages the recess in the flange.
- ▶ Screw the inner weight (5) onto the bolt and tighten it down firmly.

- ▶ Screw the outer weight (4) with the hex head screw (3) into the thread of the inner weight and tighten it down firmly.

One of two weights may be mounted on each side of the extra weight as required.

Weight on each side	Total extra weight
1	2 kg
2	4 kg

#### NOTICE

The maximum allowable extra weight is 4 kg. Never use a heavier extra weight as this may damage the machine.

#### MultiEngine with wheels

If the MultiEngine is already equipped with wheels (special accessory), see chapter on "Wheels", additional parts are required to mount the extra weights.

In such a case have the extra weight mounted by your servicing dealer.

STIHL recommends that you have servicing and repair work carried out exclusively by an authorized STIHL servicing dealer.

## 10 Wheels

For convenient transport, the MultiEngine can be retrofitted with a set of wheels (special accessory).

Always use original STIHL wheels. Using other wheels can lead to damage to the machine and personal injuries.

### 10.1 Installing wheels

**No additional weight is attached to the MultiEngine**

To simplify installation, turn the machine so that it rests on the handles.

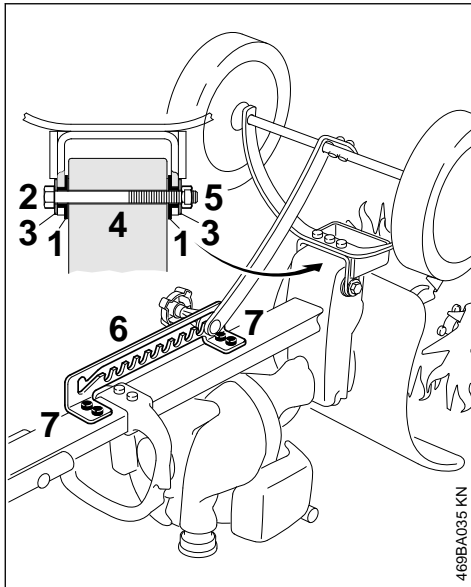

- ▶ Insert the two sleeves (1) in the frame
- ▶ Push the frame onto the flange
- ▶ Insert the bolt (2) with the washer (3) through the hole (4) in the flange
- ▶ Fit the washer (3) and tighten it down with the nut (5)
- ▶ Fasten the notched plate (6) to the frame with the screws (7) in the threaded holes – in the process, push the notched plate toward the handle
- ▶ The wheels must fold down automatically in working position; if necessary, loosen the nut (5) by a quarter turn

### Additional weight is attached to the MultiEngine

If additional weight (special accessory) – see "Additional weight" – is already attached to the MultiEngine, then additional parts are required in order to install wheels.

In this case, have the wheels installed by a servicing dealer.

STIHL recommends that maintenance and repair work be carried out only by authorized STIHL dealers.

## 10.2 Folding the wheels in and out

The wheels can be locked in various positions.

If the wheels are not needed during work, fold in the wheels.

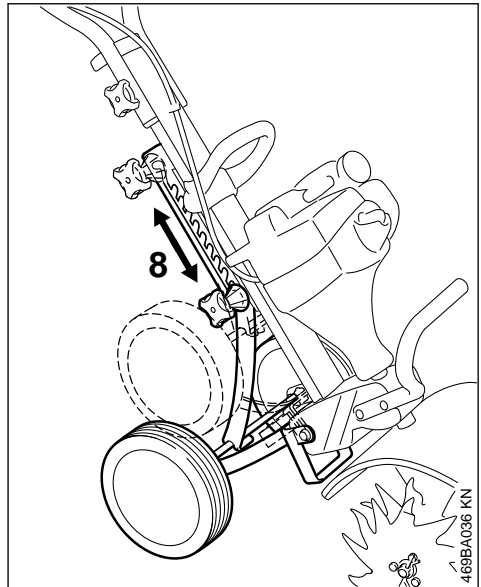

- ▶ Loosen knob (8)
- ▶ Engage knob in the desired working position and tighten it

## 11 Operating Instructions

### 11.1 During break-in period

A factory-new machine should not be run at high revs (full throttle off load) for the first three tank fillings. This avoids unnecessary high loads during the break-in period. As all moving parts have to bed in during the break-in period, the frictional resistances in the engine are greater during this period. The engine develops its maximum power after about 5 to 15 tank fillings.

### 11.2 During Operation

After a long period of full throttle operation, allow the engine to run for a short while at idle speed so that engine heat can be dissipated by the flow of cooling air. This protects engine-mounted components (ignition, carburetor) from thermal overload.

### 11.3 After Finishing Work

Storing for a short period: Wait for the engine to cool down. Empty the fuel tank and keep the machine in a dry place, well away from sources of ignition, until you need it again. For longer out-of-service periods – see "Storing the Machine".

## 12 Replacing the Air Filter

### 12.1 If There is a Noticeable Loss of Engine Power

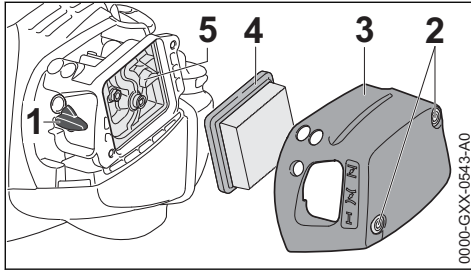

- ▶ Move the choke lever (1) to .
- ▶ Loosen the screws (2).
- ▶ Remove the filter cover (3).
- ▶ Clean away loose dirt from around the filter.
- ▶ Remove the filter element (4).
- ▶ Replace dirty or damaged filter element (4).

### 12.2 Replacing the filter element

- ▶ Install the filter element (4) in the filter housing (5) and fit the cover.
- ▶ Insert the screws (2) and tighten them down firmly.

## 13 Adjusting the Carburetor

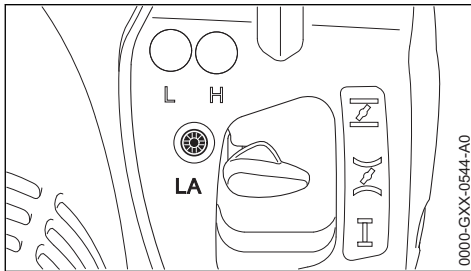

The carburetor has been set at the factory to provide an optimum fuel-air mixture under most operating conditions.

### 13.1 Adjusting Idle Speed

#### Engine stops while idling

- ▶ Warm up the engine for about 3 minutes.
- ▶ Turn the idle speed screw (LA) slowly clockwise until the engine runs smoothly – the MultiTool must not run.

#### MultiTool runs when the engine is idling

- ▶ Turn the idle speed screw (LA) counterclockwise until the MultiTool stops moving and then

turn the screw about another 1/2 to 3/4 turn in the same direction.

**! WARNING**

If the MultiTool continues to run when the engine is idling, have your machine checked and repaired by your servicing dealer.

## 14 Spark Arresting Screen in Muffler

**! WARNING**

To reduce the risk of fire caused by hot particles escaping from the machine, never operate the machine without a spark arresting screen, or with the spark arresting screen damaged. Do not modify the muffler or spark arresting screen.

### NOTICE

According to the law or regulations in some countries or federal states, certain operations may only be carried out if a properly serviced spark arresting screen is provided.

- ▶ If the engine is down on power, check the spark arresting screen in the muffler.
- ▶ Wait for the muffler to cool down

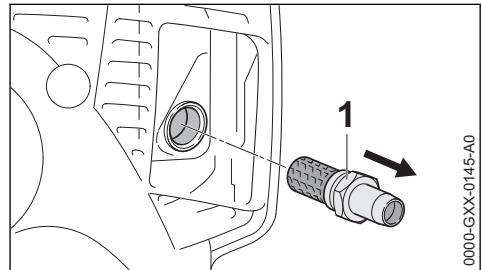

- ▶ Use the combination wrench to unscrew the connector
- ▶ Clean the spark arresting screen. If the screen is damaged or heavily carbonized, fit a new one
- ▶ Insert the connector and tighten it down firmly with the combination wrench

## 15 Spark Plug

- ▶ If the engine is down on power, difficult to start or runs poorly at idle speed, first check the spark plug.

- ▶ Fit a new spark plug after about 100 operating hours – or sooner if the electrodes are badly eroded. Install only suppressed spark plugs of the type approved by STIHL – see "Specifications".

### 15.1 Removing the Spark Plug

- ▶ Shut off the engine.

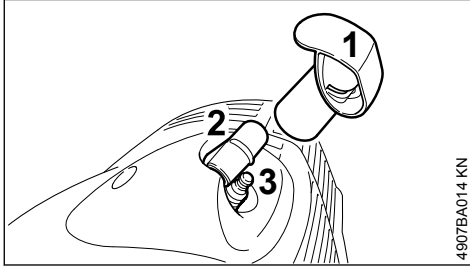

4907BA014 KN

The spark plug boot (2) is under the cap (1).



**WARNING**

The cap (1) protects the spark plug boot from damage. Do not operate the machine without a cap – replace a damaged cap.

- ▶ Remove the cap (1).
- ▶ Pull off the spark plug boot (2).
- ▶ Allow the spark plug (3) to cool down.
- ▶ Unscrew the spark plug (3).

### 15.2 Checking the Spark Plug

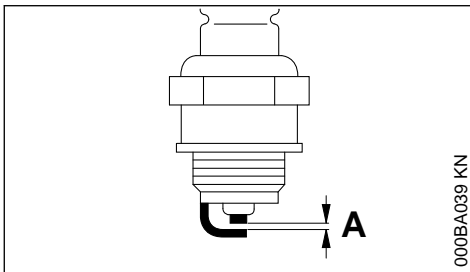

000BA039 KN

- ▶ Clean dirty spark plug.
- ▶ Check electrode gap (A) and readjust if necessary – see "Specifications".
- ▶ Rectify the problems which have caused fouling of the spark plug.

Possible causes are:

- Too much oil in fuel mix.
- Dirty air filter.
- Unfavorable running conditions.

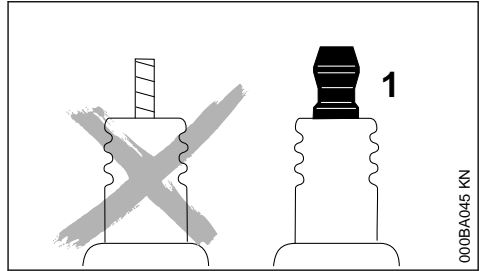

000BA045 KN



**WARNING**

Arcing may occur if the adapter nut (1) is loose or missing. Working in an easily combustible or explosive atmosphere may cause a fire or an explosion. This can result in serious injuries or damage to property.

- ▶ Use resistor type spark plugs with a properly tightened adapter nut.

### 15.3 Installing the spark plug

- ▶ Screw the spark plug into the cylinder.
- ▶ Press the boot firmly onto the spark plug.

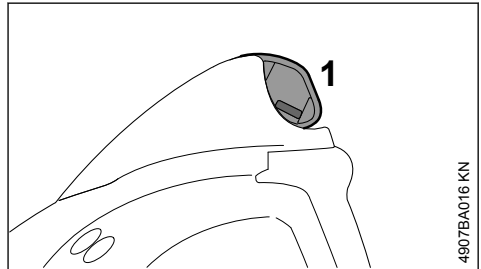

4907BA016 KN

- ▶ Push the cap (1) on to the spark plug boot as far as stop.

## 16 Engine Running Behavior

If engine running behavior is unsatisfactory even though the air filter is clean and the carburetor is properly adjusted, the cause may be the muffler.

Have the muffler checked for contamination (carbonization) by your servicing dealer.

STIHL recommends that you have servicing and repair work carried out exclusively by an authorized STIHL servicing dealer.

## 17 Storing the Machine

For periods of about 30 days or longer

- ▶ Drain and clean the fuel tank in a well-ventilated area.

- ▶ Dispose of fuel properly in accordance with local environmental requirements.
- ▶ If a manual fuel pump is fitted: Press the manual fuel pump at least 5 times.
- ▶ Start the engine and run it at idling speed until it stops
- ▶ Thoroughly clean the unit, especially the cylinder fins and air filter
- ▶ Remove, clean and inspect the attachment.
- ▶ Store the machine in a dry and secure location  
Keep out of the reach of children and other unauthorized persons

Fold the handle down and hang up the machine by the handle support.

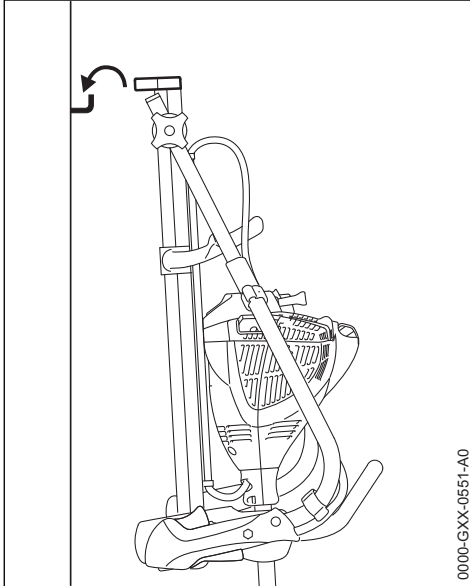

0000-GXX-0551-A0

## 18 Maintenance and Care

The following intervals apply for normal operating conditions. The specified intervals must be shortened accordingly when working for longer than normal or under difficult cutting conditions (extensive dust, etc.).		Before starting work	At the end of work and/or daily	Whenever tank is refilled	Weekly	Monthly	Annually	If faulty	If damaged	As required
Complete machine	Visual inspection (condition, leaks)	X		X						
	Clean		X							
Control handle	Function test	X		X						
Air filter	Clean							X		X



The following intervals apply for normal operating conditions. The specified intervals must be shortened accordingly when working for longer than normal or under difficult cutting conditions (extensive dust, etc.).		Before starting work	At the end of work and/or daily	Whenever tank is refilled	Weekly	Monthly	Annually	If faulty	If damaged	As required
	replace								X	
Manual fuel pump (if present)	check	X								
	Have repaired by a specialist dealer <sup>1)</sup>								X	
Fuel pickup body in fuel tank	check							X		
	Have replaced by servicing dealer <sup>1)</sup>						X		X	X
Fuel tank	Clean							X		X
Carburetor	Check idle adjustment, the work tool must not turn	X		X						
	Readjust idle speed									X
Spark plug	Adjust electrode gap							X		
	Replace after every 100 hours of operation									
Intake port for cooling air	Visual inspection		X							
	Clean									X
Spark arresting screen in muffler	Check if installed	X								
	Check or replace <sup>1)</sup>						X			
All accessible screws, nuts and bolts (not adjusting screws)	Tighten									X
Safety information label	replace								X	

<sup>1)</sup>STIHL recommends STIHL dealers

## 19 Minimize Wear and Avoid Damage

Observing the instructions in this manual helps reduce the risk of unnecessary wear and damage to the power tool.

The power tool must be operated, maintained and stored with the due care and attention described in this owner's manual.

The user is responsible for all damage caused by non-observance of the safety precautions, operating and maintenance instructions in this manual. This includes in particular:

- Alterations or modifications to the product not approved by STIHL.

- Using tools or accessories which are neither approved or suitable for the product or are of a poor quality.
- Using the product for purposes for which it was not designed.
- Using the product for sports or competitive events.
- Consequential damage caused by continuing to use the product with defective components.

### 19.1 Maintenance Work

All the operations described in the "Maintenance Chart" must be performed on a regular basis. If these maintenance operations cannot be performed by the owner, they should be performed by a servicing dealer.

STIHL recommends that you have servicing and repair work carried out exclusively by an authorized STIHL servicing dealer. STIHL dealers are regularly given the opportunity to attend training courses and are supplied with the necessary technical information.

If these maintenance operations are not carried out as specified, the user assumes responsibility for any damage that may occur. Among other parts, this includes:

- Damage to the engine due to neglect or deficient maintenance (e.g. air and fuel filters), incorrect carburetor adjustment or inadequate cleaning of cooling air inlets (intake ports, cylinder fins).
- Corrosion and other consequential damage resulting from improper storage.
- Damage to the machine resulting from the use of poor quality replacement parts.

## 19.2 Parts Subject to Wear and Tear

Some parts of the power tool are subject to normal wear and tear even during regular operation in accordance with instructions and, depending on the type and duration of use, have to be replaced in good time. Among other parts, this includes:

- Clutch
- Filters (air, fuel)
- Rewind starter
- Spark plug

## 20 Main Parts

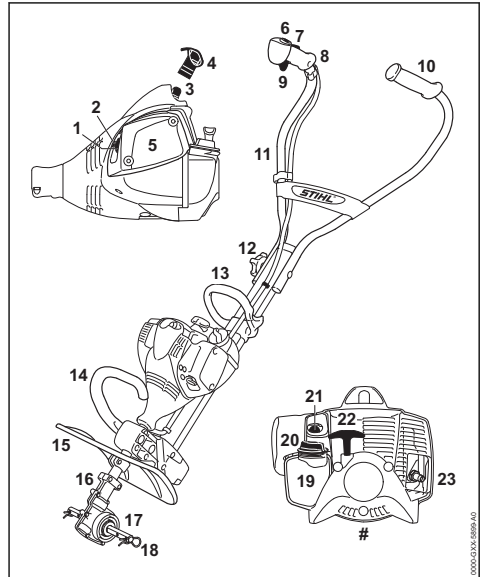

- 1 Choke lever
- 2 Carburetor adjusting screw
- 3 Spark plug boot
- 4 Cap
- 5 Air filter cover
- 6 Stop switch
- 7 Throttle trigger lockout
- 8 Control handle
- 9 Throttle trigger
- 10 Left handle
- 11 Handlebar
- 12 Knob
- 13 Loop handle
- 14 Carrying handle
- 15 Deflector
- 16 Gearbox
- 17 Axle
- 18 Hitch pin
- 19 Fuel tank
- 20 Tank cap
- 21 Manual fuel pump
- 22 Starter grip
- 23 Muffler with spark arresting screen

## # Serial Number

**21 Specifications****21.1 Engine**

Single cylinder two-stroke engine

Displacement: 27.2 cc  
 Bore: 34 mm  
 Stroke: 30 mm  
 Engine power to ISO 8893: 0.85 kW (1.2 bhp) at 7,500 rpm  
 Idle speed: 2,800 rpm  
 Cut-off speed: 8,900 rpm  
 Max. output shaft 200 rpm speed (Multi-Tool):

**21.2 Ignition System**

Electronic magneto ignition

Spark plug NGK CMR 6 H,  
 (resistor type): BOSCH USR 4  
 AC  
 Electrode gap: 0.5 mm

**21.3 Fuel System**

All position diaphragm carburetor with integral fuel pump

Fuel tank capacity: 330 cc (0.33 l)

**21.4 Weight**

**Dry, without attachment**  
 7.9 kg

**21.5 Sound and Vibration Levels**

For further details on compliance with Vibration Directive 2002/44/EC, see

[www.stihl.com/vib](http://www.stihl.com/vib)

**MultiEngine with MultiTool**

Version of MultiTools – see "Approved Multi-Tools".

**21.6 BF-MM and BK-MM**

Noise and vibration data are measured at idling and rated operating speed in a ratio of 1:6.

**Sound pressure level  $L_{peq}$  in accordance with EN 709**

87 dB(A)

**Sound power level  $L_w$  in accordance with EN 709**

96 dB(A)

**Vibration level  $a_{hv,eq}$  to EN 709**

	Handle, left	Handle, right
BF-MM:	3.8 m/s <sup>2</sup>	4.4 m/s <sup>2</sup>
BK-MM:	3.7 m/s <sup>2</sup>	4.0 m/s <sup>2</sup>

**21.7 FC-MM**

Noise and vibration data is measured at idling and rated maximum engine speed in a ratio of 1:1.

**Sound pressure level  $L_{peq}$  in accordance with ISO 11789**

91 dB(A)

**Sound power level  $L_w$  in accordance with ISO 11789**

100 dB(A)

**Vibration level  $a_{hv,eq}$  to EN 11789**

	Handle, left	Handle, right
FC-MM	4.1 m/s <sup>2</sup>	5.1 m/s <sup>2</sup>

**21.8 FS-MM**

Noise and vibration data is measured at idling and rated maximum engine speed in a ratio of 1:6.

**Sound pressure level  $L_{peq}$  in accordance with DIN EN 14910**

93 dB(A)

**Sound power level  $L_w$  in accordance with DIN EN 14910**

102 dB(A)

**Vibration level  $a_{hv,eq}$  in accordance with DIN EN 14910**

	Handle, left	Handle, right
FS-MM	4.0 m/s <sup>2</sup>	4.3 m/s <sup>2</sup>

**21.9 KB-KM, KW-KM**

Noise and vibration data is measured at idling and rated maximum engine speed in a ratio of 1:6.

**Sound pressure level  $L_{peq}$  in accordance with ISO 11201**

94 dB(A)

### Sound power level $L_w$ in accordance with EN ISO 3744

102 dB(A)

### Vibration level $a_{hv,eq}$ in accordance with ISO 20643

	Handle, left	Handle, right
KB-MM	4.0 m/s <sup>2</sup>	4.1 m/s <sup>2</sup>
KW-MM	4.0 m/s <sup>2</sup>	4.1 m/s <sup>2</sup>

## 21.10 MF-MM and RL-MM

Noise and vibration data is measured at idling and rated maximum engine speed in a ratio of 1:6.

### Sound pressure level $L_{peq}$ in accordance with EN 13684

MF-MM:	94 dB(A)
RL-MM	93 dB(A)

### Sound power level $L_w$ in accordance with EN 13684

MF-MM:	101 dB(A)
RL-MM	102 dB(A)

### Vibration level $a_{hv,eq}$ to EN 13864

	Handle, left	Handle, right
MF-MM:	4.1 m/s <sup>2</sup>	4.5 m/s <sup>2</sup>
RL-MM	4.1 m/s <sup>2</sup>	4.5 m/s <sup>2</sup>

The K-factor in accordance with Directive 2006/42/EC is 2.0 dB(A) for the sound pressure level and sound power level; the K-factor in accordance with Directive 2006/42/EC is 2.0 m/s<sup>2</sup> for the vibration level.

## 21.11 REACH

REACH is an EC regulation and stands for the Registration, Evaluation, Authorization and Restriction of Chemical substances.

For information on compliance with the REACH regulation (EC) No. 1907/2006 see

[www.stihl.com/reach](http://www.stihl.com/reach)

## 21.12 Exhaust Emissions

The CO<sub>2</sub> value measured in the EU type approval procedure is specified at

[www.stihl.com/co2](http://www.stihl.com/co2)

in the product-specific technical data.

The measured CO<sub>2</sub> value was determined on a representative engine in accordance with a standardized test procedure under laboratory conditions and does not represent either an explicit or implied guarantee of the performance of a specific engine.

The applicable exhaust emission requirements are fulfilled by the intended usage and maintenance described in this User Manual. The operating license shall be void if the engine is modified in any way.

## 22 Maintenance and Repairs

Users of this machine may only carry out the maintenance and service work described in this user manual. All other repairs must be carried out by a servicing dealer.

STIHL recommends that you have servicing and repair work carried out exclusively by an authorized STIHL servicing dealer. STIHL dealers are regularly given the opportunity to attend training courses and are supplied with the necessary technical information.

When repairing the machine, only use replacement parts which have been approved by STIHL for this power tool or are technically identical. Only use high-quality replacement parts in order to avoid the risk of accidents and damage to the machine.

STIHL recommends the use of original STIHL replacement parts.

Original STIHL parts can be identified by the STIHL part number, the **STIHL** logo and the STIHL parts symbol  (the symbol may appear alone on small parts).

## 23 Disposal

Contact the local authorities or your STIHL servicing dealer for information on disposal.

Improper disposal can be harmful to health and pollute the environment.

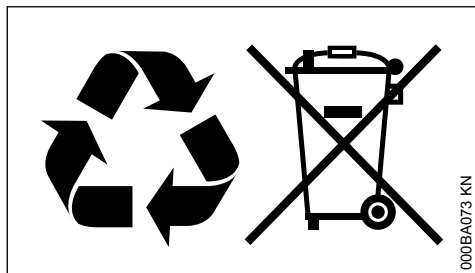

- ▶ Take STIHL products including packaging to a suitable collection point for recycling in accordance with local regulations.
- ▶ Do not dispose with domestic waste.

*J. Hoffmann*

Dr. Jürgen Hoffmann

Director Product Certification & Regulatory Affairs

CE

## 24 EC Declaration of Conformity

ANDREAS STIHL AG & Co. KG  
Badstr. 115  
D-71336 Waiblingen

Germany

declare under our sole responsibility that

Designation:	MultiEngine
Make:	STIHL
Series:	MM 56
Serial identification number:	4604
Displacement:	27.2cm <sup>3</sup>

conforms to the relevant provisions of Directives 2011/65/EU, 2006/42/EC and 2014/30/EU and has been developed and manufactured in compliance with the following standards in the versions valid on the date of production:

EN ISO 12100, EN 55012, EN 61000-6-1 (in conjunction with the specified MultiTools BF-MM, BK-MM, RL-MM, FC-MM, MF-MM, KB-MM, KW-MM)

The MultiEngine described here may be operated only in conjunction with the MultiTools approved by STIHL for use with this MultiEngine.

Technical documents deposited at:

ANDREAS STIHL AG & Co. KG  
Produktzulassung

The year of manufacture and serial number are applied to the product.

Done at Waiblingen, 15.07.2021

ANDREAS STIHL AG & Co. KG

pp





[www.stihl.com](http://www.stihl.com)



0458-489-8321-B



0458-489-8321-B